

Accelerometer combined thermometer



Features

- Temperature signal output
- Corrosion resistant
- Hermetic seal
- Case isolated
- ESD protection
- Reverse wiring protection

Application

- Oil & gas machine
- Gear box monitoring
- Mining machine
- Bearing monitoring

Description

Model 340AT is an intrinsic safety IEPE accelerometer permitting simultaneous vibration and temperature measurements. 340AT features an annular shear ceramic crystal which exhibits excellent output stability over time. The accelerometer incorporates an internal circuit with in a two-wire IEPE system which transmits its low impedance voltage output through the same cable that supplies the constant current power. Integrated thermal sensor transfer the temperature output by voltage signal. Signal ground is internal shielded and isolated from the outer case of the unit. Polarity inversion protection for the amplify circuit is inherent in the circuit design. The welded stainless-steel construction provides a hermetic housing. The standard MIL-C-5015 glass insulated connector provides long-term stability over the operating temperature range. Side outlet cable enable the compact installation and discretional cable direction. In addition to adhesive mounting, 340A has $\varnothing 6.4$ through holes for screw mounting on the test object. The 340AT provides wide frequency response and shock resistance, which is ideal for industrial vibration monitoring under incidental shock environment. Senter's model 20A-L is a MIL-C-5015 3-pins connector mating cable for the sensor.

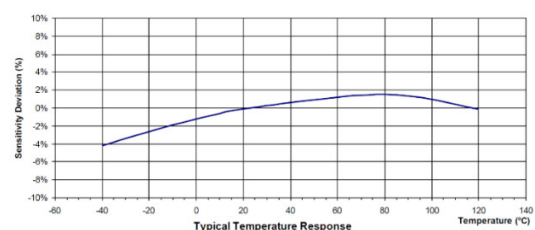
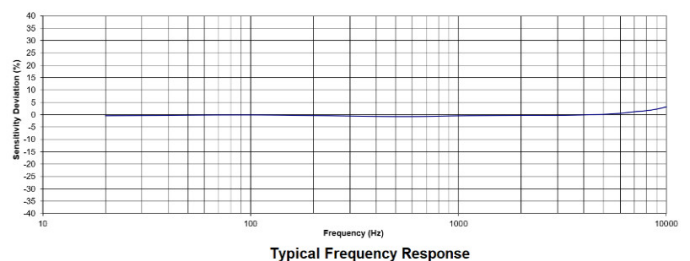
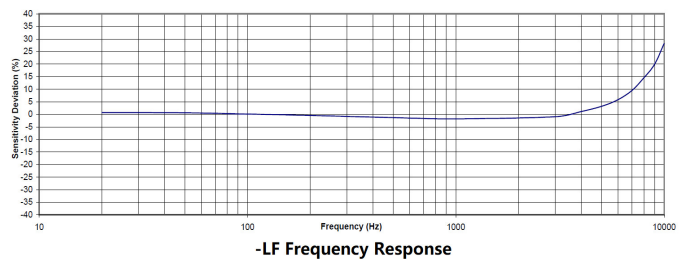
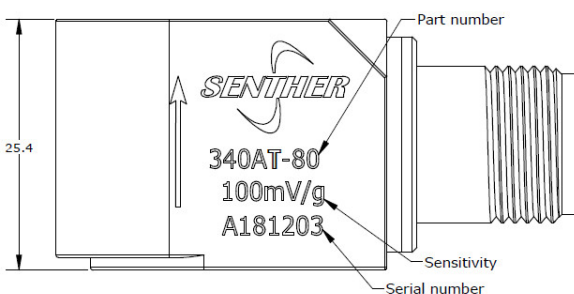
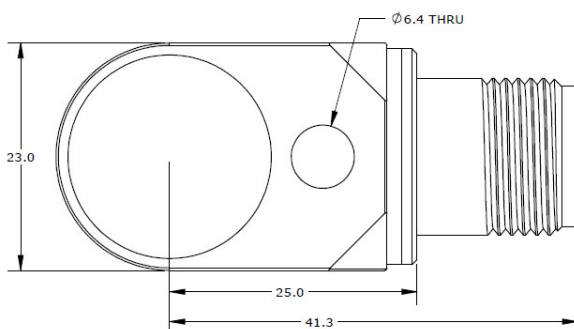

Specification

Typical at +24°C (+75°F), 24Vdc, 4 mA and 100Hz, unless otherwise stated.

Part Number	-5-LF	-10-LF	-10	-20	-80	-500	
Dynamic Range	±5	±10	±10	±20	±80	±500	g, peak
Sensitivity ±10%	1000	500	500	250	100	10	mV/g
Freq. Resp. ±5%	0.6-3000	0.6-3000	1-3000	1-6000	1-6000	1-6000	Hz
Freq. Resp. ±3dB	0.1-5000	0.1-5000	.3-5000	.3-8000	.3-8000	.3-8000	Hz
Resonant Frequency	18	18	25	25	25	25	kHz
Transverse Sensitivity	<5	<5	<5	<5	<5	<5	%
Temp. Resp., -55 to +125°C	±10	±10	±10	±10	±10	±10	%
Non-Linearity	±1	±1	±1	±1	±1	±1	%FSO
Residual Noise	0.00015	0.0002	0.0005	0.0005	0.0005	0.0010	g RMS
Shock Limit	2000	2000	2000	5000	5000	5000	g
Warm-up Time	<5	<5	<2	<2	<2	<2	second
Weight	117	117	110	110	110	110	Gram

ITEMS	SPEC	UNIT
BIAS VOLTAGE	10 to 14	Vdc
OUTPUT IMPEDANCE	<100	Ω
INSUL RESIST (@100Vdc)	>100	MΩ
SUPPLY VOLTAGE	18 to 30	Vdc
SUPPLY CURRENT	2 to 10	mA
OPERATING TEMPERATURE	-55 to +125°C (-67 to 257°F)	°C (°F)

Temperature Sensor:

ITEMS	SPEC	UNIT
OUTPUT SENSITIVITY	10	mV/°C
OUTPUT VOLTAGE AT 0°C	500	mV
ACCURACY	±1	°C
RANGE	-40~125	°C

Overall Specification:

ITEMS	SPEC	UNIT
OPERATING TEMPERATURE	-40 to +125°C	
HUMIDITY	HERMETICALLY SEALED	
CASE MATERIAL	STAINLESS STEEL	
SENSING ELEMENT	PIEZO CERAMIC	
CONNECTOR	3 Pin MIL-C-5015	
GROUNDING	INTERNALLY SHIELDED, CASE ISOLATED	

Accessories

Calibration certificate included.

Part Number	Description	Availability
PM0118	¼-28x1¼ hex head mounting screw	One stud Included
PM0333	M6x35 hex head mounting screw	
MB0004	Magnet mounting adapter	Optional
20A-10	10 meter mating cable with MIL-C-5015 3pins connector	Optional
IN-03	3 channels IEPE signal conditioner	Optional
IN-91	Portable vibration analyzer	Optional
IN-SDG	8 channels data acquisition system	Optional

Measurement configuration

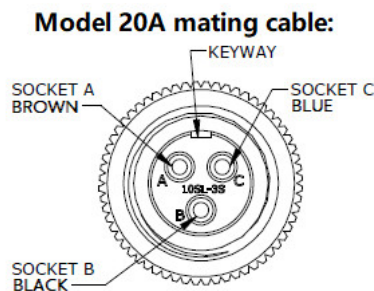
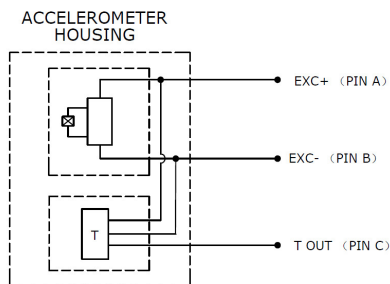
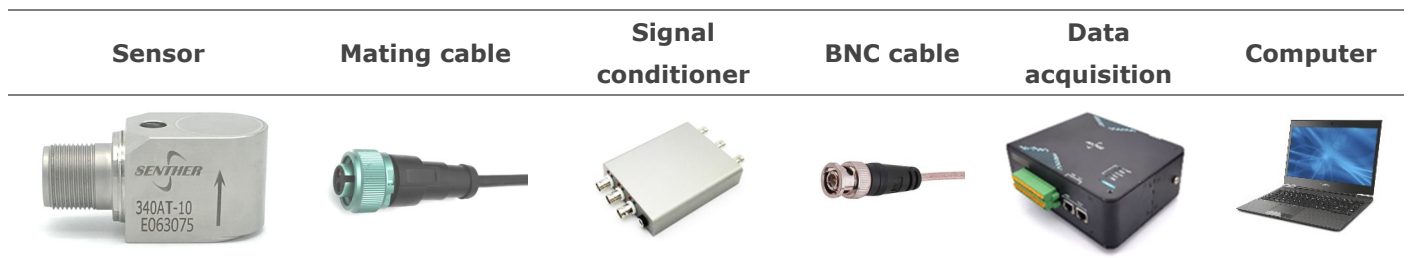

Ordering information

340	AT	-	80	-	LF	-	A
Model	Output signal	-	Range	-	Low frequency option	-	Mounting stud
340	A=IEPE output T=Temperature signal output	-	5=5g 10=10g 20=20g 80=80g 500=500g	-	LF= Low frequency response	-	A= ¼-28 mounting screw B= M6 mounting screw C*=Special

